

Istruzioni di uso ed installazione – ITALIANO

GEMINI è la mini barriera all'infrarosso attivo a doppia lente dalle dimensioni molto contenute. Precablati e pronti per l'installazione è composta da un'unità trasmittente ed una ricevente con 8 frequenze digitali selezionabili.

CARATTERISTICHE TECNICHE E CONSUMI:

Portata massima:	100 m (GEMINI 100) 60 m (GEMINI 60) 30 m (GEMINI 30)	Portata minima:	50 m (GEMINI 100) 30 m (GEMINI 60) 15 m (GEMINI 30)
------------------	--	-----------------	---

Frequenze digitali selezionabili 8
Sincronizzazione ottica
Allineamento con mirino e segnalazione a LED
Angolo di rilevazione verticale 20°, orizzontale 180°
Temperatura di funzionamento da -25°C a +55°C
Disqualifica incorporata
Buzzer di allarme e di stato in fase di programmazione
Tempo di risposta regolabile tra 50 e 240m/sec.
Alimentazione da 13.8 a 24 Vdc
Assorbimento massimo 100 mA
Tensione minima di funzionamento (livello segnale) da 1,8 a 2,0 Volt
Dimensioni 170x80x80 cm
Grado di protezione IP55
Funzionamento disqualifica:
Quando la potenza del segnale diminuisce lentamente fino a 0,8 V il rilevatore attiva l'allarme anti-flog (uscita fault), quando il segnale scende a 0,4 V, allarme attivo.



DESCRIZIONE MORSETTIERA E DIP SWITCH RICEVITORE:

MORSETTIERA

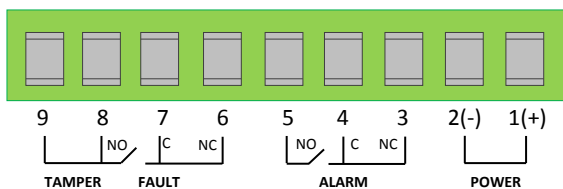

- 1 – 2: alimentazione 13,8 / 24 Vdc
- 3 – 4 – 5: uscita allarme NC o NO
- 6 – 7 – 8: uscita disqualifica (fault) NC o NO
- 8 – 9: uscita tamper NC

DIP SWITCH

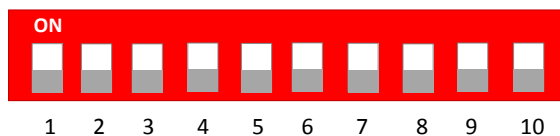

- 1 – 2 – 3: impostazione frequenza
- 4 – 5 – 6: non utilizzati
- 7 – 8: selezione funzione (vedere TABELLA FUNZIONI a PAG.2)
- 9: ON/OFF cicalino
- 10: ON/OFF display

DESCRIZIONE MORSETTIERA E DIP SWITCH TRASMETTITORE:

MORSETTIERA

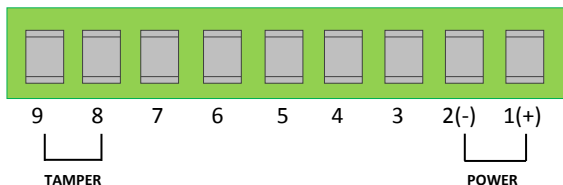

- 1 – 2: alimentazione 13,8 / 24 Vdc
- 3 – 4 – 5 – 6 – 7: non utilizzati
- 8 – 9: uscita tamper NC

DIP SWITCH

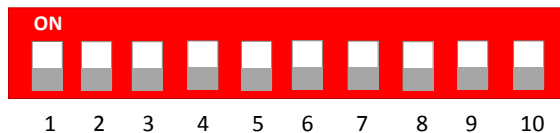

- 1 – 2 – 3: impostazione frequenza
- 4 – 5 – 6: non utilizzati
- 7 – 8: selezione funzione (vedere TABELLA FUNZIONI a PAG.2)
- 10: ON/OFF display

INSTALLAZIONE:

- Sia sul ricevitore che sul trasmettitore posizionare tutti i dip switch su OFF ed alimentare le barriere
- Impostare la frequenza utilizzando la seguente procedura:
 - Sia su RX che su TX, utilizzando i dip switch 1, 2 e 3 definire la frequenza, vedere a fianco per i settaggi (numero frequenze disponibili 8)
 - Per confermare la frequenza posizionare il dip switch 7, su entrambi i profili, su ON
 - Una volta impostata la frequenza riportare il dip switch 7, su entrambi i profili, su OFF
- Orientare il gruppo ottico del ricevitore nella direzione del trasmettitore e viceversa fino a quando sulla ricevente il led rosso sarà spento e si legga sul display la massima tensione possibile. Per le regolazioni verticali agire sulla vite di regolazione, mentre per quelle orizzontali intervenire ruotando la staffa (vedere IMMAGINE 1). Se necessario aiutarsi con il mirino (vedere IMMAGINE 2).

		NUMERO FREQUENZA (DA 1 A 8)							
DIP		1	2	3	4	5	6	7	8
	1	OFF	ON	OFF	ON	OFF	ON	OFF	ON
	2	OFF	OFF	ON	ON	OFF	OFF	ON	ON
	3	OFF	OFF	OFF	OFF	ON	ON	ON	ON

IMMAGINE 1



IMMAGINE 2



TABELLA FUNZIONI:

		FUNZIONE			
DIP		LIVELLO SEGNALE	IMPOSTAZIONE FREQUENZA	NON UTILIZZATO	VISUALIZZAZIONE FREQUENZA / ID
	7	ON	ON	OFF	OFF
	8	ON	OFF	ON	OFF

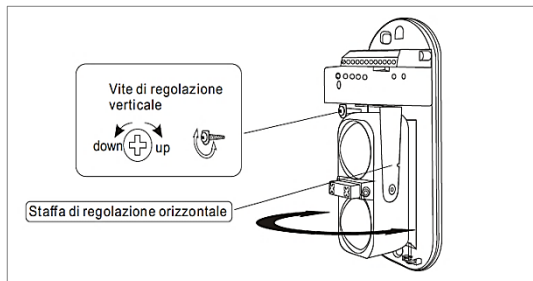
AVVERTENZA:

Una volta impostata la frequenza non lasciare il dip switch 7 in ON ed il dip switch 8 in OFF, **ma portare il solo dip switch 8 in ON (modalità visualizzazione livello segnale).**

Se si vuole da questo settaggio vedere la frequenza impostata fare come segue: **mettere in OFF per primo il dip switch 7 e solo dopo il dip switch 8, non viceversa.**

Se da qui si vuole ritornare a visualizzare il livello segnale (7 e 8 in ON)

mettere in ON per primo il dip switch 8 e solo dopo il dip switch 7, non viceversa.

NOTA: il livello segnale è visibile solo sul profilo RX

NOTE PER L'INSTALLAZIONE:

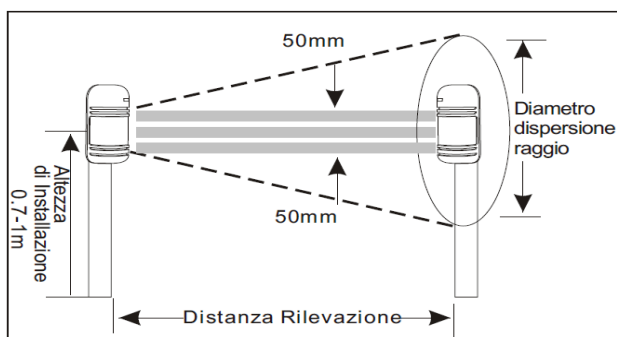
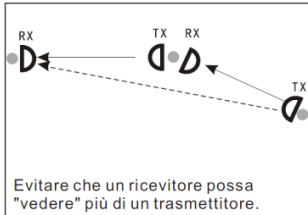
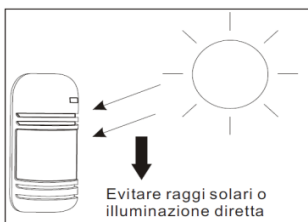
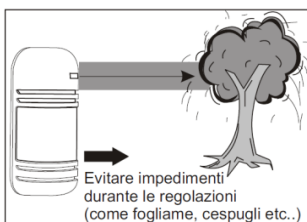

Modello	Distanza di Rilevazione	Diametro Dispersione Raggio
GEMINI 30	30m	0.7m
GEMINI 60	60m	1.5m
GEMINI 100	100m	2.1m

MITECH® srl

Uffici:
Via Roncaglia, 14
20146 Milano – Italia

Produzione:
Via Ramazzone, 23
43010 Fontevivo (PR) – Italia

Tel.: +39 02.48006383
Fax: +39 02.48025620
tech@mitech-security.com



www.mitech-security.com

Installation and user manual – ENGLISH

GEMINI is the mini IR barrier with dual lens with and small dimensions. Ready for installation it consists of a transmitter and a receiver with 8 digital frequencies selectable.

GENERAL FEATURES AND ABSORPTION

Maximum range:	100 m (GEMINI 100) 60 m (GEMINI 60) 30 m (GEMINI 30)	Maximum range:	50 m (GEMINI 100) 30 m (GEMINI 60) 15 m (GEMINI 30)
----------------	--	----------------	---

8 digital frequencies
Optical synchronization
Aligning with the viewfinder and LED signal
Vertical angle 20 °, horizontal 180 °
Operating temperature from -25 ° C to + 55 ° C
Disqualification system
Buzzer alarm and status during programming
Response time adjustable between 50 and 240 m / sec.
Power supply 13.8 – 24 Vdc
Maximum absorption 100 mA
Minimum operating voltage (signal level) from 1.8 to 2.0 volts
Dimensions 170x80x80 cm
Protection class IP55 (IP65 with box TOWER GARDEN)

Anti-flog function:

Where signal strength decrease slowly to 0,8 V the detector will active anti-flog alarm (fault output), when signal decrease to 0,4 V, will active alarm.



DESCRIPTION OF CLAMP AND DIP SWITCH RECEIVER:

CLAMP

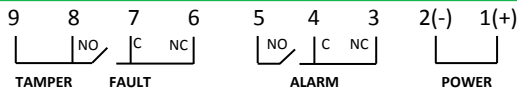
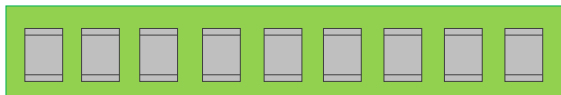

1 – 2: 13,8 / 24 Vdc
3 – 4 – 5: alarm output NC o NO
6 – 7 – 8: fault output NC o NO
8 – 9: tamper output NC

DIP SWITCH



1 2 3 4 5 6 7 8 9 10

1 – 2 – 3: setting frequency
4 – 5 – 6: not used
7 – 8: function selection (see table page 2)
9: ON/OFF buzzer
10: ON/OFF display

DESCRIPTION OF CLAMP AND DIP SWITCH TRANSMITTER:

CLAMP

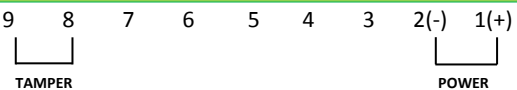

1 – 2: tamper output 13,8 / 24 Vdc
3 – 4 – 5 – 6 – 7: not used
8 – 9: tamper output NC

DIP SWITCH



1 2 3 4 5 6 7 8 9 10

1 – 2 – 3: setting frequency
4 – 5 – 6: not used
7 – 8: function selection (see table 2)
10: ON/OFF display

INSTALLATION:

- Position all dip switches on OFF both the receiver and the transmitter and power supply the barriers.
- Use this procedure to set the frequency:
 - Both on RX profile and on TX profile, use dip switches 1, 2 and 3 to define the frequency, see table (available 8 frequencies)
 - To confirm the frequency both on RX profile and on TX profile, position the dip switch 7 on ON
 - Once the frequency is set, return the dip switch 7, on both profiles on OFF
- Orient the receiver's optical unit in the direction of the transmitter and vice versa until the red LED on the receiver is turned off and the maximum voltage is read on the display. For vertical adjustments, act on the adjusting screw, while for horizontal adjustments turn the bracket (see IMAGE 1). If necessary, help with the viewfinder (see IMAGE 2).

		FREQUENCY NUMBER (FROM 1 TO 8)							
DIP		1	2	3	4	5	6	7	8
	1	OFF	ON	OFF	ON	OFF	ON	OFF	ON
	2	OFF	OFF	ON	ON	OFF	OFF	ON	ON
	3	OFF	OFF	OFF	OFF	ON	ON	ON	ON

IMAGE 1

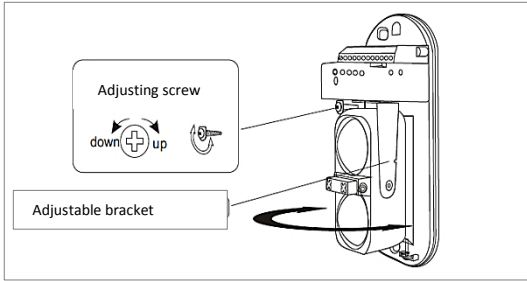
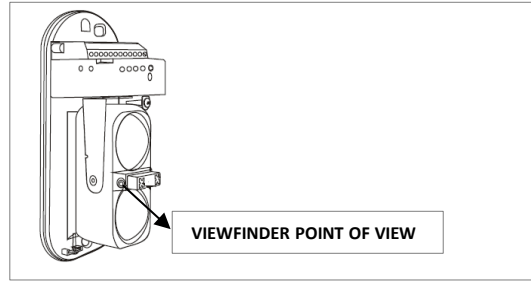

IMAGE 2



FUNCTION TABLE:

		FUNCTION			
DIP		LIVELLO SEGNALE	IMPOSTAZIONE FREQUENZA	NON UTILIZZATO	VISUALIZZAZIONE FREQUENZA / ID
	7	ON	ON	OFF	OFF
	8	ON	OFF	ON	OFF

WARNING:

Once the frequency is set, do not leave the dip switch 7 in ON and the dip switch 8 in OFF, **but bring the dip switch 8 in ON (signal level display mode).**

If you want from this setting see the frequency set, do the following:

set the dip switch 7 in OFF and only after also the dip switch 8, not the reverse.

If you want to return to signal level display mode (7 and 8 in ON), do the following:

set the dip switch 8 in ON and only after also the dip switch 7, not the reverse.

NOTE: The signal level is only visible on the RX profile

NOTES FOR INSTALLATION:

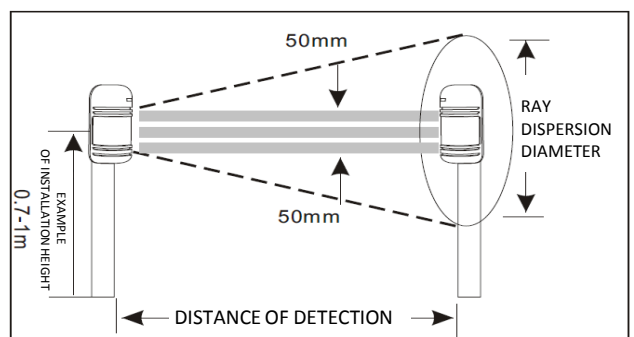
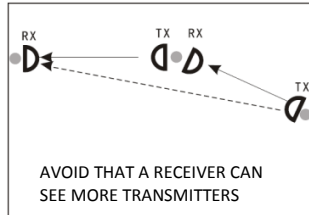
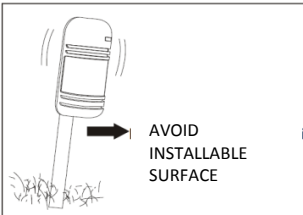
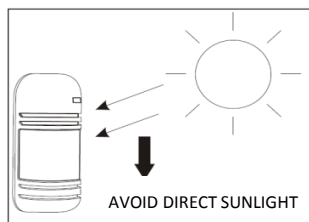
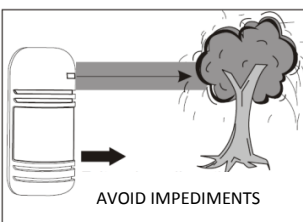

ITEM	DISTANCE OF DETECTION	RAY DISPERSION DIAMETER
GEMINI 30	30m	0.7m
GEMINI 60	60m	1.5m
GEMINI 100	100m	2.1m

MITECH® srl

Offices:
Via Roncaglia, 14
20146 Milano – Italia

Production:
Via Ramazzone, 23
43010 Fontevivo (PR) – Italia

Phone: +39 02.48006383
Fax: +39 02.48025620
tech@mitech-security.com



www.mitech-security.com